



POWEROPTIMAL
THE FUTURE OF ENERGY

elon SMART HOT WATER SYSTEM

PowerOptimal Elon® Smart Thermostat Installation Manual



Version number: 1.15
Version date: 2025/02/03
Enquiries: info@poweroptimal.com
Address: 88 12th Avenue
Kleinmond
7195

Patented: GB2583814, ZA2019/02129, ZA2022/08516, EP4100979,
US 12,122,914

Patents pending: PCT/ZA2024/050065, GB2618349, ZA2024/08399,
CH2023800381161, US 18/861,142, EP23723798.7, AU2023265634,
ZA2024/08845



SAFETY WARNING

- The Elon® Smart should **only be installed in standard Kwikot electric geysers**. It is NOT compatible with other geyser brands.
- We strongly recommend that the Elon Smart is only installed by a qualified plumber or electrician.
- If you are installing solar PV together with the Elon Smart, we strongly recommend that you use a reputable and experienced solar photovoltaic (PV) system installer to install your solar PV modules, and strictly according to the installation instructions in the full Elon Smart installation manual, which is available for download from the PowerOptimal website.
- Installers should wear the appropriate safety and personal protective equipment (for example a safety harness and/or fall protection equipment when working at height).
- **The solar PV modules and wiring installation must be signed off by an electrical contractor registered with the Department of Labour** (the so-called “wireman’s licence”) The electrician must provide you with a **supplementary Certificate of Compliance (CoC)** once installation is completed. (A supplementary CoC is not required if only the Elon Smart is installed with no solar PV.)
- **Solar PV modules exposed to the sun are live** (i.e. will produce electricity) and can give an electric shock. Special care should be taken and only trained solar PV installers should install the modules.
- **Do not attempt to** alter or service the electrical installation, or open the Elon® Smart unit or controller for any purpose.
- Use the Elon® Smart **only for its intended purpose**.
- **Always** make sure that every wiring connection is **properly tightened**.
- **Do not earth** either of the solar module wires (but do earth the frames).
- All installation wiring should be at least 2.5mm².
- Avoid coiling, since DC switching can create damaging spikes.
- Keep all wires as short as possible.

Refer to the PowerOptimal website for the following:

	Elon® Smart User Manual	www.poweroptimal.com/manuals
	Training videos for installers	www.poweroptimal.com/training

Table of Contents

Table of Contents.....	4
1. Required tools.....	5
2. Basic wiring diagram	6
3. Solar PV array installation	7
4. Elon® Smart installation.....	9
A. Inserting the Elon Smart unit into the geyser.....	9
B. Preparing and wiring the AC disconnect switch to the Elon Smart	9
C. Preparing and wiring the DC disconnect switch to the Elon Smart Thermostat	13
D. Final insertion, testing and closing the cover.....	13
E. Configuring the Elon Smart Thermostat using the Elon Smart App.....	14
F. Applying warning labels and QR code label	18
Appendix A. List of Alarms and How to Resolve Them	20
Appendix B. Basic Troubleshooting Guide for Electricians	25
Appendix C. Solar yield	27
C1. Solar irradiance levels	27
C2. Geographic features	28
C3. Azimuth / horizontal angle	28
C4. Inclination or tilt angle.....	28
C5. Shading.....	28
C6. Ambient temperature.....	29
C7. Minimum distance from roof edges	29
Appendix D. Deciding on Size of Solar Array.....	30
Appendix E. PV array and geyser (water heater) element matching	34
Appendix F. Technical Specification Summary: Elon® Smart.....	35
Appendix G. Surge Protection Device (SPD) Recommendations	36
G1. SANS 10142-1 The wiring of premises Part 1: Low-voltage installations.....	36
G2. SANS 60364-7-712 (2018) Low Voltage Electrical Installations: Requirements for special installations or locations – Solar photovoltaic (PV) power supply systems	37
Appendix H. IEC/SANS and EMC Test Certificates: Elon® Smart.....	40
Appendix I. Warranty	43
Appendix J. Terminology.....	44
Notes.....	45

1. Required tools

The following tools are required for the installation. Use insulated tools wherever applicable.

- Solar modules (mounting) - *please refer to solar module / mounting installation instructions – the below is only a guideline:*
 - Cordless screwdriver with bits
 - Drill
 - Set of drill bits (wood, steel, stone)
 - Set of screwdrivers
 - Set of Allen (hex) keys
 - Tape measure
 - Grinder (tile roof installations)
 - Permanent marker
 - Chalk
 - Hammer
- Solar modules (electrical):
 - AC/DC Clamp meter
 - Side-cutting pliers
 - Screwdriver set
 - Crimping tool
 - 4 mm² wire (double insulated) (or other size as determined by solar PV voltage and wire length)
 - Cable ties
- Elon Smart - *the following additional tools:*
 - Insulated No. 2 Phillips or Pozidriv screwdriver
 - Insulated 5mm flat screwdriver
 - Wire Stripper for 1.5 -6mm wire
 - Wire Cutter for 1.5 -6mm wire
 - Cell phone with Elon Smart app installed
 - No. 8 spanner or socket for geyser earth stud

2. Basic wiring diagram

Note 1: Both AC & DC circuit breakers or isolators must be installed **within 1.5m of the geyser** (water heater), line of sight.

Note 2: Surge Protection Device (SPD) only required in higher lightning strike density areas (such as parts of Gauteng and Mpumalanga), or where the DC cables are long. See **Appendix F**.

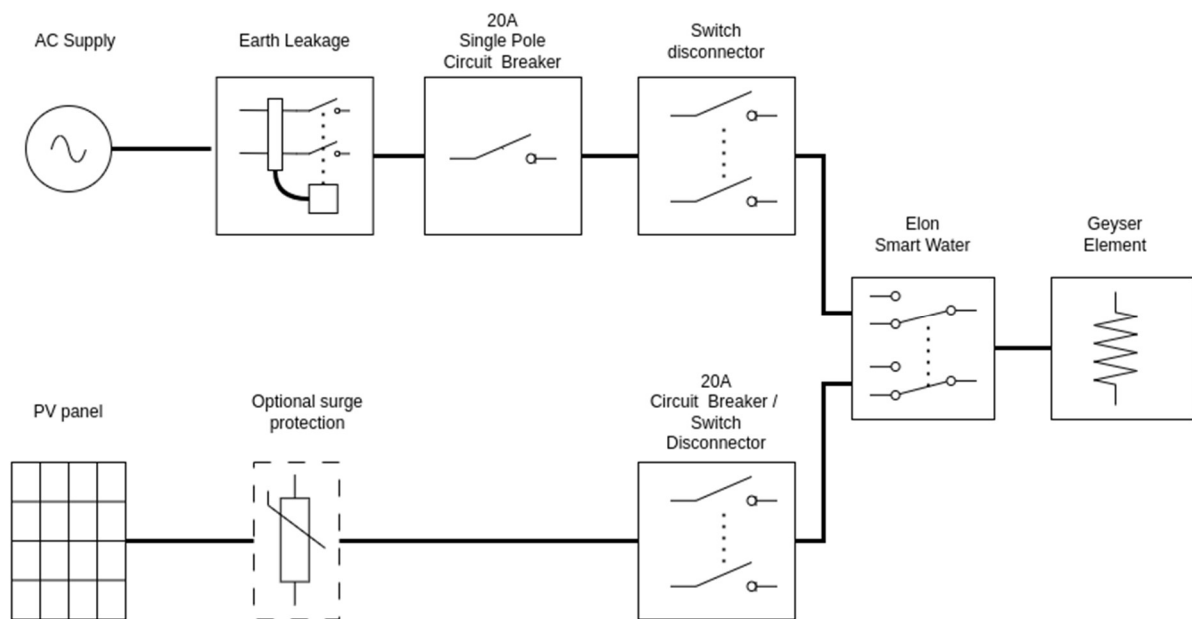

Figure 2.1 Basic wiring diagram for the Elon Smart.

3. Solar PV array installation

Modules should only be installed by a **trained solar PV installation technician**. Array **position and orientation have a major impact on power production** (see Appendix B).

Review the instructions from your solar PV module supplier / manufacturer on installation.



Please note: Your installer should comply with SANS 10142-1 (Standard for low voltage installations) and SANS 60364-7-712 when doing your solar PV installation. If they are not well familiar with these standards, you should look for a different solar PV installer.

SAPVIA (South African Photovoltaic Industry Association) has made available an excellent guide to solar PV installations. See:

<https://www.pvgreencard.co.za/Solar%20PV%20Guidelines%20-%20Digital%20Spread%20High-res.pdf>

NB: Refer to Appendices C & D for guidelines on selecting the right size solar PV array for the user requirements, and for correctly matching the solar PV array and the geyser element.

The below installation steps are a **general guide only** – compliance with the abovementioned standards is **compulsory**.

1. A critical starting point is **safety gear**: ensure that all installers wear a helmet and insulated safety gloves, as well as fall protection safety gear that is securely fixed to anchor points if work will be done on a roof or elevated area.
2. The solar PV array should only consist of one string of 2 to 5 modules in series, or two parallel strings 2 to 5 modules each. **Do not exceed the DC voltage or current ratings of the Elon® Smart (230V DC and 15A DC) under any circumstances.**
3. Attach bracket / mounting structure to roof. Use mounting structure recommended by solar module supplier for roof type and size of solar modules.
4. Fix the solar PV modules to the mounting structure and connect the module cables to each other.
5. If practical, cover the modules to ensure that there is no potential for electric shock whilst installing the system.
6. Ground the mounting structure only.
7. Install the wiring from the solar PV array to the Elon® Smart unit in the ceiling space. Ensure circuit breakers / isolators are in the “Open” position. Installation of a Surge Protective Device (SPD) between the solar PV array and the Elon® Smart is required in high lightning strike areas, such as parts of Gauteng and Mpumalanga. See **Appendix F** for more information.

8. **Last step** is to connect the array to the rest of the wiring, making sure that both the positive and negative wires are fully isolated from ground and keeping circuit breakers / isolators in the “Open” position.

Note: no separate earth spike is required for Elon solar PV installations. That is because the Elon never disconnects the AC supply to the house and does not interfere with the existing earthing arrangement.

Some “DO’s & DON’T’s” when installing solar PV arrays:

Your solar PV installer should not make any of these basic mistakes, but they are listed here just in case.

- DO earth the PV array structure.
- DO isolate the wires from the PV array structure.
- DON’T use different sizes, types or specifications of modules together in the same string or array.
- DON’T install solar arrays where they will be partially shaded during any season of the year if it can be avoided at all.
- DO install the arrays so that there is space for inspection or maintenance when needed.
- DO use cabling of the correct size for your solar array.
- DON’T install the solar array flush with your rooftop. Use struts / brackets that ensure an unrestricted **air gap of at least 40 mm** between the roof and the modules.
- DON’T walk on the modules.
- DO ensure that connectors are kept clean and away from water.
- DON’T leave exposed modules in short circuit.
- DO ensure that all connectors are securely fastened.
- DON’T exceed the voltage ratings of any components.
- DO properly route and secure all cables.
- DON’T coil cables.

4. Elon® Smart installation

A. Inserting the Elon Smart unit into the geyser

1. Make sure both the AC and the DC disconnect switches are in the **off** position.
2. Take off geyser cover
3. Take out existing thermostat
4. Insert the Elon Smart Thermostat stem at least 1/3rd of the way into the pocket (see **Figure 4.1**). Don't insert it fully yet.



Figure 4.1. STEP 4: Insert the Elon Smart Thermostat stem at least 1/3rd of the way into the thermostat pocket. Don't insert it fully yet.

B. Preparing and wiring the AC disconnect switch to the Elon Smart

5. Cut a 2.5mm² flexible cord for connecting Elon Smart to the AC disconnect switch (see **Figure 4.2**).
 - a. The flexible cord has stranded wire which makes routing under the geyser cover much easier.
 - b. It is not recommended to use solid 2.5mm² twin core + earth. If it is used take care, ensure wire lengths and routing do not put undue strain on the wiring causing it to be pulled out of the screw terminals when the geyser cover is put back.
 - c. The cord needs an additional 15 cm to route under the geyser cover.
 - d. The AC terminals on the Elon Smart can handle 1.5 – 4 mm² flexible cables, but at least 2.5 mm² is recommended.

6. Strip cord 15 cm to expose live neutral and earth wires.
7. Strip and crimp O-lug to earth.
8. Cut live and neutral wires to 8 cm and strip back the insulation by 6 mm.
9. Thread the cord through the geyser cover.
10. Connect cord to AC disconnect switch.
11. Connect the 2 Earth wires (green and yellow) coming out the right side of the Elon Smart and the earth from the AC cord to the geyser earth point (see **Figure 4.3**).

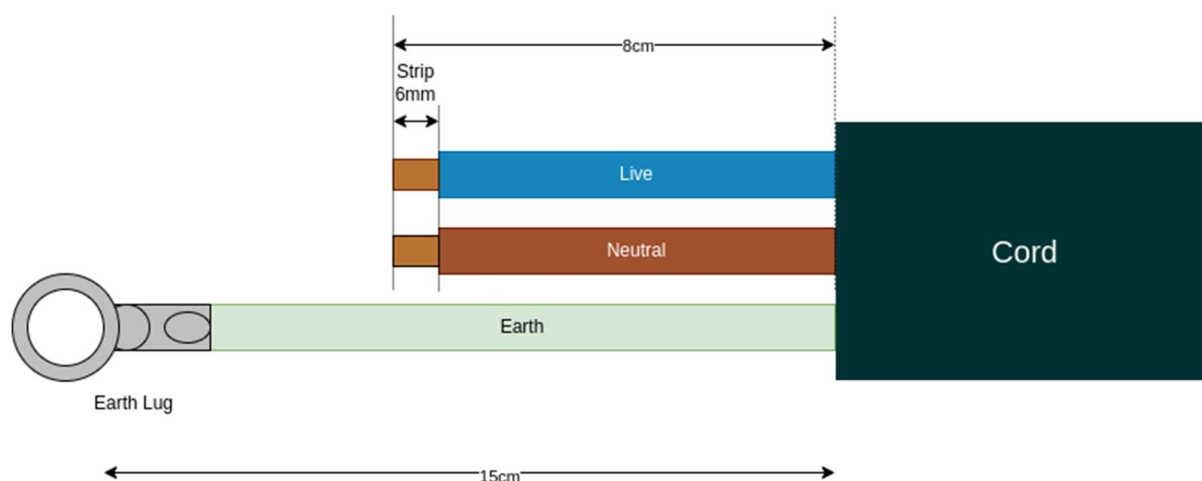

Figure 4.2. STEPS 5 – 8: Preparation of AC cord to wire between AC disconnect switch and the Elon Smart thermostat.

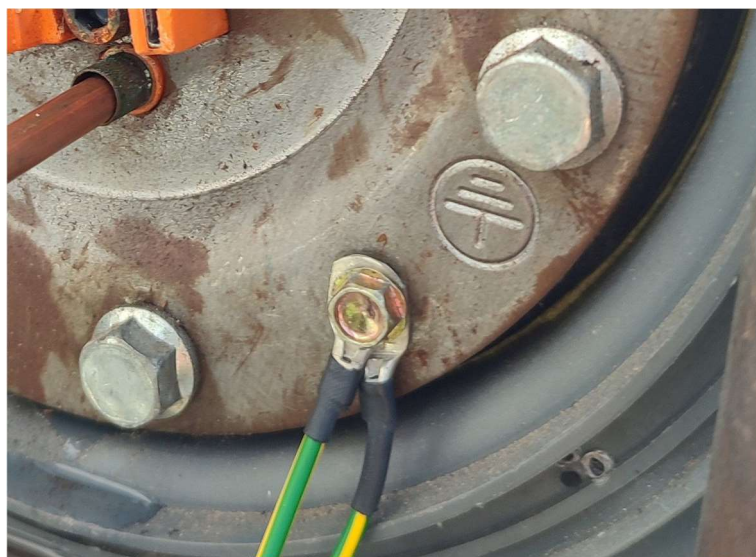

Figure 4.3. STEP 11: Connect the two earth wires (green & yellow) from the Elon Smart thermostat and the earth from the AC cord to the geyser earth point.

12. Insert the Live and Neutral into the screw terminals labelled AC and tighten as per the following steps:
 - a. The AC screw Terminals are located on the left of the Elon Smart Thermostat (see **Figure 4.4**).



Figure 4.4. STEP 12: The AC screw terminals are located on the left of the Elon Smart Thermostat

- b. The wires are easier to insert if you rotate the Elon Smart 90° in the geyser socket. This gives a clear view of the screw terminals cage clamp (see **Figure 4.5**).

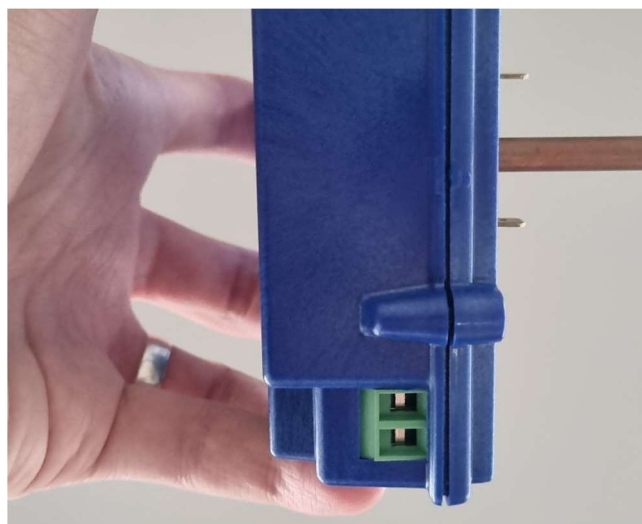

Figure 4.5. STEP 12b: Rotate the Elon Smart 90° in the thermostat pocket to make the AC wires easier to insert.

- c. Insert live (Brown or Red wire) into the right cage clamp marked **L**.
- d. Insert neutral (Blue or Black wire) into the left Cage clamp marked **N**.
- e. Open the cage clamps fully by screwing counterclockwise before inserting the wires to make sure the wire is inserted into the cage clamp and not the space below.
- f. Make sure no strands are folded back when you insert the wires into the cage clamps before tightening.
- g. For 1.5mm² solid core wire, removing the insulation for 12mm, folding back, and squeezing with a set of pliers provides a more secure fit in the cage clamp when tightening (see **Figure 4.6**).
- h. Tug lightly on both wires to make sure they are tightened sufficiently.

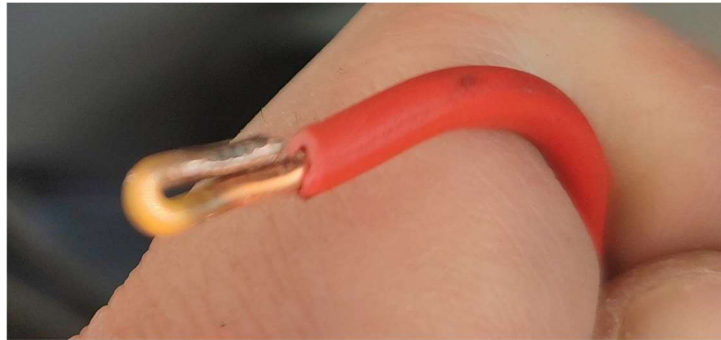

Figure 4.6. STEP 12g: for solid core wire, fold back and squeeze the wire with a set of pliers to give the cage clamp a better grip.

C. Preparing and wiring the DC disconnect switch to the Elon Smart Thermostat

13. Cut 2 pieces of solar double insulated wire for connecting Elon Smart to DC disconnect switch.
 - a. The DC terminals of the Elon Smart can handle 2.5 – 6 mm² flexible cable, but 4mm² or 6mm² double insulated UV protected solar wire is recommended to minimise wiring losses.
 - b. 4mm² or 6mm² stranded wire clamps better than 2.5mm² wire in the screw terminals.
 - c. Bootlace ferrules can be used but are not required.
14. Connect one end of the wires to the DC disconnect switch.
15. Strip the other end of both wires to 10 mm.
16. Thread wires through geyser cover.
17. Insert the Solar Wires into the screw terminals labelled DC and tighten using a No. 2 Phillips screwdriver.
 - a. The DC screw Terminals are located on the right of the device.
 - b. Open the cage clamps fully by screwing counterclockwise before inserting the wires to make sure the wire is inserted into the cage clamp and not the space below.
 - c. The wires are easier to insert if you rotate the Elon Smart 90° or 180° in the geyser socket. This gives a clear view of the screw terminals cage clamp.
 - d. Insert **DC +** (positive) into the right cage clamp marked **+**
 - e. Insert **DC -** (negative) into the left cage clamp marked **-**
 - f. Make sure no strands are folded back when you insert the wires into the cage clamps before tightening.
 - g. If the wires are stripped to the required 10mm, the wires can be inserted into the cage clamp up to the insulation before tightening.
 - h. If using an electric screwdriver with a torque setting, tighten to 1.2 Nm.
18. Give the wires a light tug to make sure they are tightened securely.

D. Final insertion, testing and closing the cover

19. Press the Elon Smart thermostat into the Element making sure the blade terminals at the bottom fully engage with the element. It should press in quite firmly.
20. On new geysers with a standard double recess Kwikot end plate the Elon Smart thermostat should fit flush to the plate.
21. Turn on the DC disconnect switch.
22. Verify DC is present on the DC screw terminals (see **Figure A1** in Appendix A).
 - a. Take care as the screws of the screw terminals are live;
 - b. Verify DC polarity is correct.
23. Turn on the AC disconnect switch.
24. Verify AC is present on the AC screw terminals (see **Figure A2** in Appendix A).
25. Turn off the AC and DC disconnect switches.
26. Scan the QR code of the Elon Smart thermostat with the Elon Smart app before closing the cover.

E. Configuring the Elon Smart Thermostat using the Elon Smart App

27. Install the **Elon Smart app** on your smart phone by searching for “Elon Smart Water” in the Google Play Store (Android) or Apple App Store (iPhone). Alternatively, scan one of the QR codes provided below using your phone camera.

NOTE: if you have already installed the app on a previous occasion, please check that you have the latest version of the app by visiting the app page in your phone’s app store and tapping on “Update” if you don’t have the latest version. For convenience, you can scan one of the below QR codes to go to the app page in your app store.



**Elon Smart App
for Android:**
**Google Play
Store**

Scan this QR code with your Android phone to install the app from the Google Play Store



**Elon Smart App
for iPhone:**
Apple App Store

Scan this QR code with your iPhone to install the app from the Apple App Store

28. Once installed the application should display the startup screen (Figure 4.7)



Figure 4.7 Start-up screen



Figure 4.8 Scanning screen

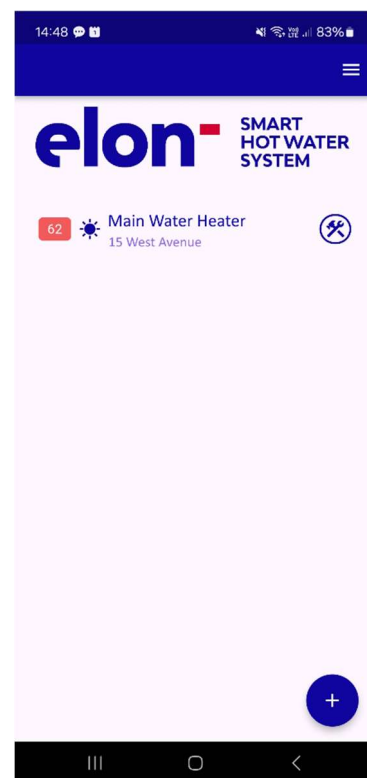

Figure 4.9 Thermostat added

29. Wait for the “App is authenticated” message to appear at the bottom of the screen.
30. Tap the **(+) (+) button** on the bottom right to add the Smart thermostat.
31. The app will display the scanning screen called “**Add Thermostat**” (**Figure 4.8**). Scan the QR code by placing it horizontal and centred on the screen. (If the code does not want to scan, try moving the phone closer and further from the QR code. Try rotating the phone into landscape mode.)
32. The app should take you back to the main screen after the thermostat has been added (**Figure 4.9**).
33. Tap the **Configure (🔧) (hammer & spanner) button** on the right of the newly added thermostat.
34. The application requests confirmation to switch to the Smart Thermostat’s hotspot (**Figure 4.10**).
35. Select “**CONNECT**”
36. The application should display the “Configure Thermostat” screen (**Figure 4.11**)
37. First configure the Wi-Fi network that the unit will use to connect to the server. Tap the right arrow (>) next to the Wi-Fi Hotspot entry.
38. The application searches for the available networks and displays them in a list (**Figure 4.12**).

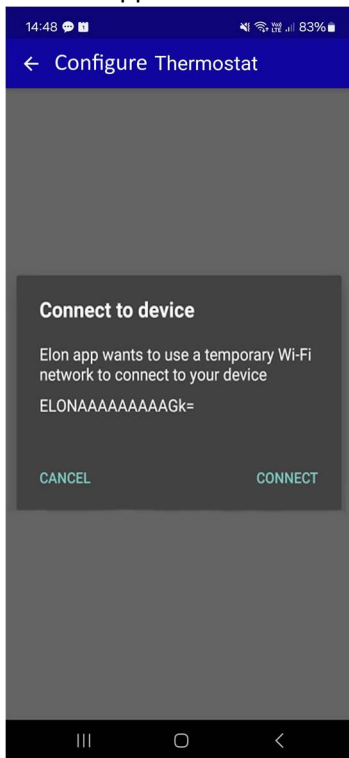

Figure 4.10 Network change

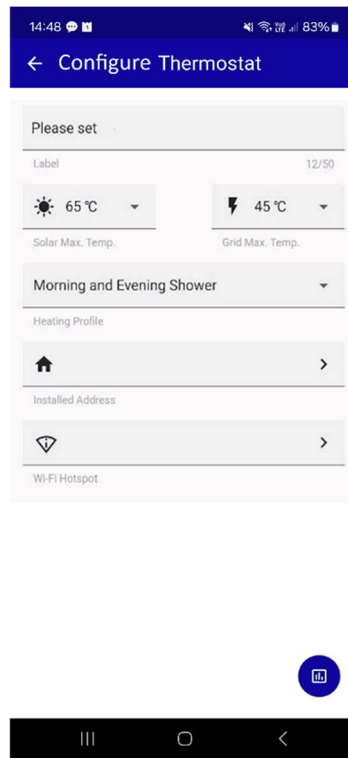

Figure 4.11 Configure screen

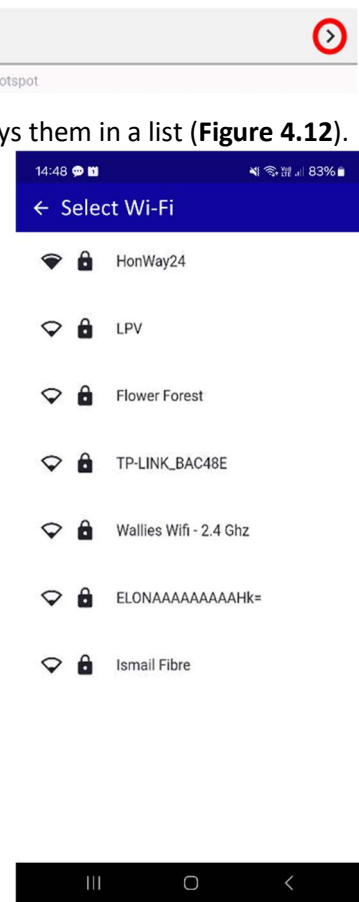

Figure 4.12 Select Wi-Fi

39. Tap on the Wi-Fi network you want the Smart Thermostat to use.
40. The application will ask for a password for the network you selected (**Figure 4.13**).
41. Enter the password and tap “**Test Connection**”.

42. If you entered the password correctly the application should take you back to the configuration screen and the network should be green.

43. Next configure the address. Click on the right arrow (>) next to the address field.



44. The app should connect to the server and obtain a list of addresses corresponding to your GPS co-ordinates (**Figure 4.14**). (You might need to switch on your phone GPS and allow the app to use your location services.)

45. Select the correct address.

46. The app should take you back to the “**Configure Thermostat**” screen (**Figure 4.15**).

47. Go to the top field called “**Label**” and enter a new name for the smart thermostat. This will be used to identify this smart thermostat in your app.



48. Now set the “**Solar Max. Temp.**” and “**Grid Max. Temp.**” temperature set points. It is best for savings and optimal solar power usage to select a lower temperature set point for grid power than for solar power. **65 °C** on **Solar** and **50 °C** on **Grid** are good set points.

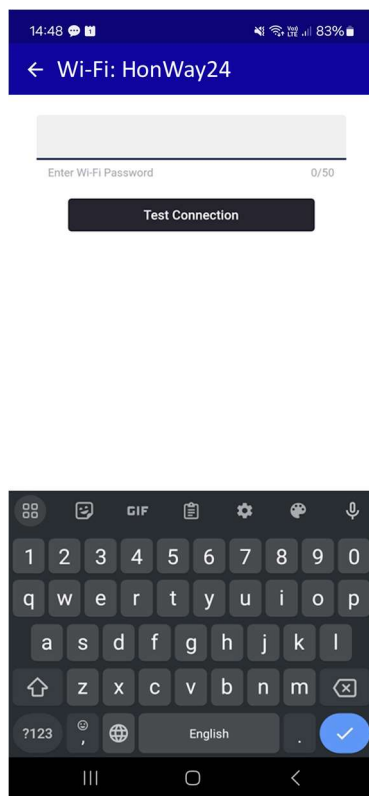
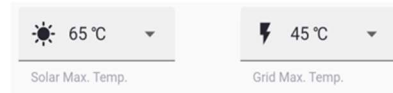

Figure 4.13 Enter Wi-Fi password

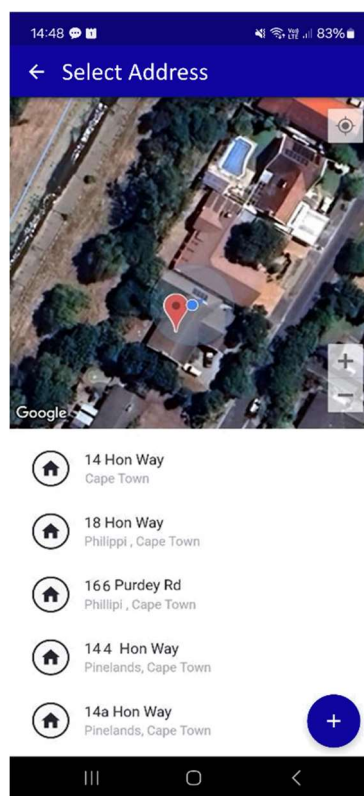

Figure 4.14 Select address

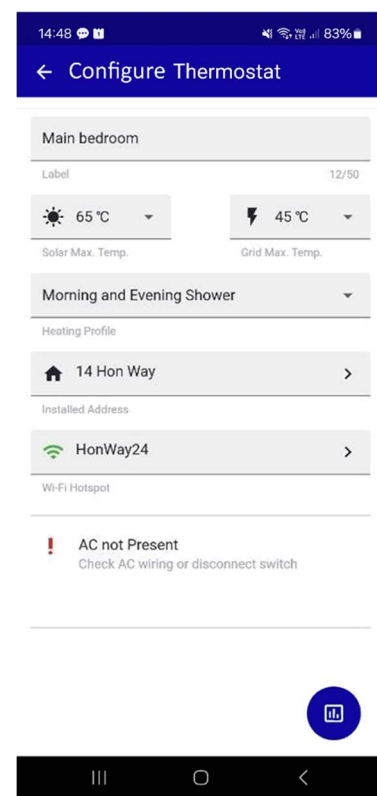

Figure 4.15 Heating settings

49. Next you can set the “**Heating Profile**” according to your preference. Select how the household wishes to use the hot water generated by the Smart thermostat (**Table 4.1**). It is typically best to start with the “**Morning and Evening Shower**” profile.

Table 4.1 Heating Profile options

Heating Profile option	Solar power use	Grid power use	Comments
Grid Only	Never	Always	Select this option if you don’t have any solar panels installed.
Solar Only	Always	Never	ONLY use solar power. NEVER use grid power.
Morning Shower	Always except for 3 am – 5 am	3 am – 5 am	Solar power will be used whenever available, and grid power will only be used early in the morning to boost water temperature to the Grid set point if the temperature is lower than that.
Evening Shower	Always except for 5 pm – 7 pm	5 pm – 7 pm	Solar power will be used whenever available, and grid power will only be used in the late afternoon to boost water temperature to the Grid set point if the temperature is lower than that.
Morning and Evening Shower	Always except for 3 am – 5 am & 5 pm – 7 pm	3 am – 5 am & 5 pm – 7 pm	Solar power will be used whenever available, and grid power will only be used in the early morning and late afternoon to boost water temperature to the Grid set point if the temperature is lower than that.

50. If there are any problems with the installation, an alarm will display below the configuration settings, indicated by a red exclamation mark (!) (**Figure 4.15**). See Appendix A for a list of alarms and how to resolve them (if needed).

51. Once you have cleared all the issues, then no more alarms will be displayed on the configuration settings screen.

Please note: DO NOT install a separate timer on the AC side to try and regulate mains power use. Use only the Elon Smart app to control mains power use. If you install a second timer, it will work at cross-purposes with the Elon and you will reduce performance and hot water availability.

F. How to delete a smart geyser from the app

To delete a smart geyser from the app, tap and hold on the device that you want to delete on the home screen.

A prompt will pop up for you to confirm whether you want to delete the device, as shown on the screenshot to the right.

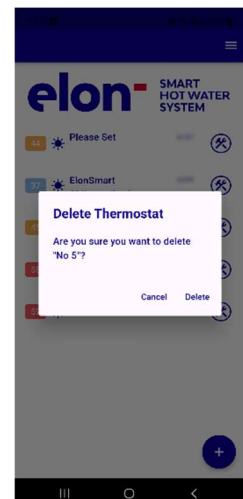

G. How to view app and device software versions

To see the current version of the app and the current versions of all software on the Elon Smart Thermostat, tap on the hamburger menu ☰ in the top right of the home screen and then tap “**About**”.



H. Applying warning labels and QR code label

1. Attach labels included with the Elon Smart (see **Figure 4.16** below):
 - a. Attach "Dual Supply" labels (a) to the AC isolator and the DC circuit breaker (or isolator).
 - b. Attach "Warning – Photovoltaic Power Source" label (b) to the DC wiring conduit in a clearly visible position.
 - c. Attach "Warning – disconnect supply circuits" label (c) to outside of geyser end cover.
 - d. Attach Elon Smart QR code label (d) to the inside of the house's DB board.



a. Warning – Dual Supply labels x 2



b. Warning – PV power source label



c. Warning – disconnect supply circuits label

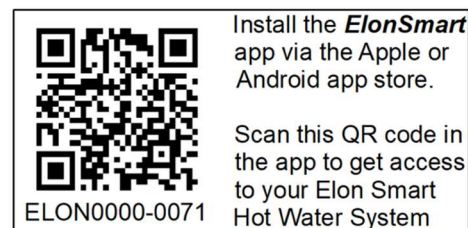

d. Elon Smart QR code label

Figure 4.16. Labels included with the Elon Smart

Appendix A. Basic Troubleshooting for Users, List of Alarms and How to Resolve Them

Here is a flow diagram with basic troubleshooting steps for users. Always check that you have the **latest version of the app** by going to the “Elon Smart Water” app in your app store.

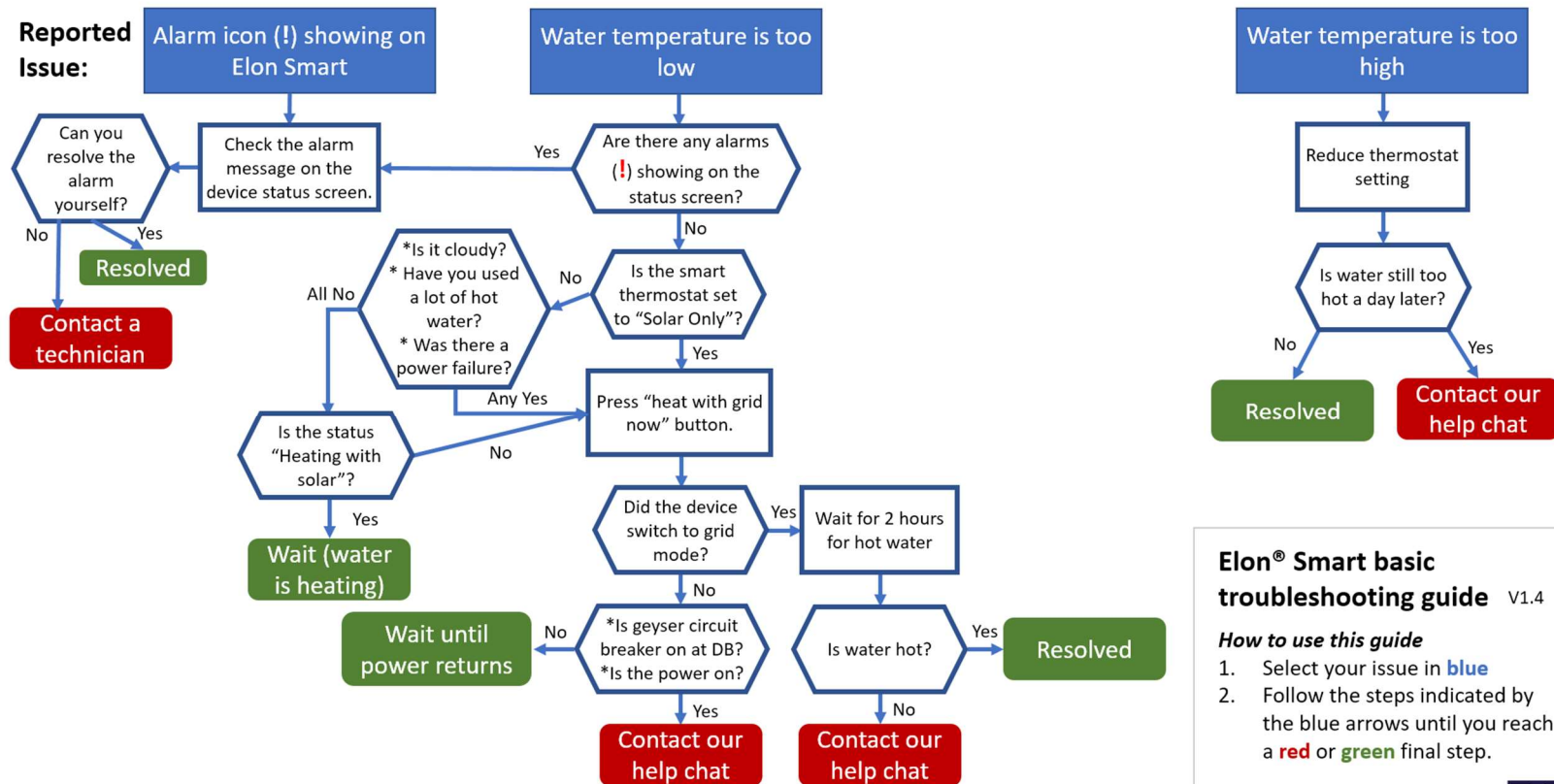

Elon® Smart basic troubleshooting guide V1.4

How to use this guide

- Select your issue in **blue**
- Follow the steps indicated by the blue arrows until you reach a **red** or **green** final step.

Reported Issue:

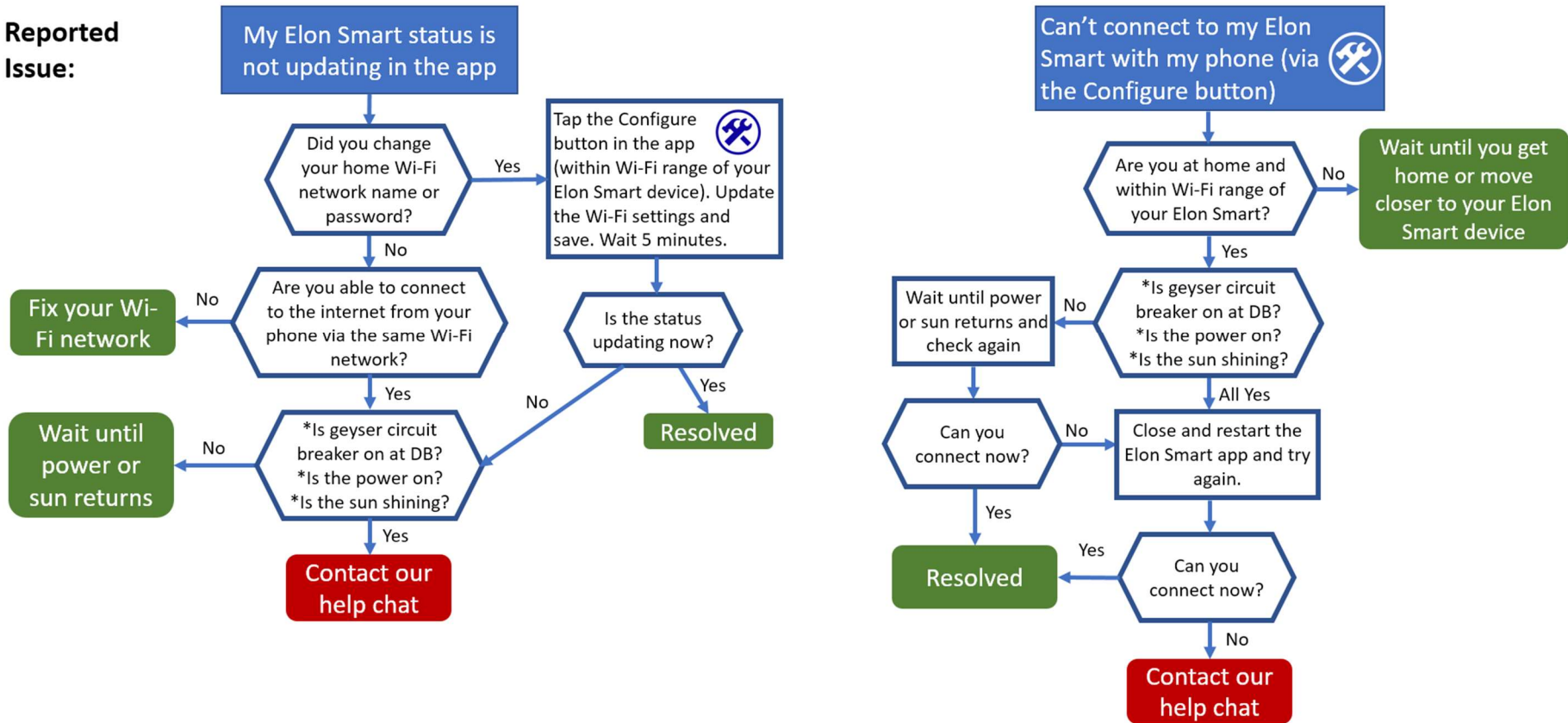

Reported Issue:

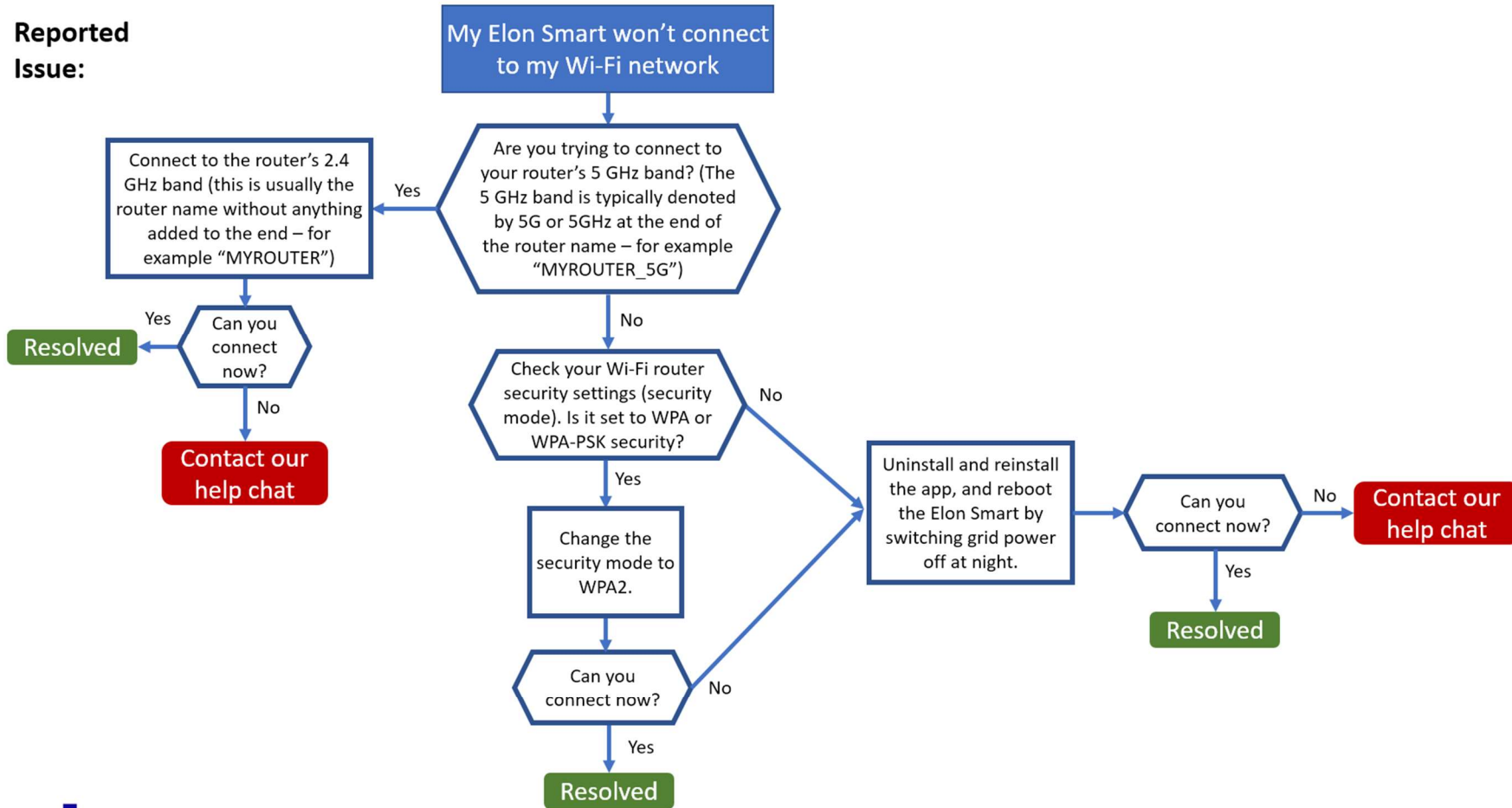

The Elon Smart has a helpful alarm system that detects and reports common issues. See the below list for the various alarms and how to resolve them.

ID	Alarm message	How to resolve the alarm
0	Element Faulty	<ul style="list-style-type: none"> a. Check that the thermostat is inserted correctly. b. If that does not clear the alarm, measure element resistance and replace if necessary.
1	Switch Failed	Contact technical support
2	DC Disconnect Failed	Contact technical support
3	No Power on AC Input	<p>This can be due to several reasons:</p> <ul style="list-style-type: none"> a. There is no AC power connected to the Elon Smart b. AC power is off at the circuit breaker in the DB board or at the AC isolator close by the Elon Smart unit. c. There is a power failure or loadshedding. <p>This alarm won't prevent the Elon Smart unit from functioning and heating water with solar (DC) power as long as there is solar power available.</p> <p>You can clear the alarm by switching the AC power on (where applicable), setting the Elon Smart heating policy to <i>Solar Only</i> (see Table 4.1) or you can leave it until AC power returns.</p>
4	Measurement Failure	Contact technical support
5	Disconnected for Safety	When there is a safety-related alarm condition, the Elon Smart will disconnect power from the geyser. To clear this alarm, you need to clear the other safety-related alarm(s).
6	Water Temperature Measurement Failure	Contact technical support
7	Ambient Temperature Exceeded	<ul style="list-style-type: none"> a. Check the installation. If the geyser is installed in direct sunlight, see if you can provide shade to the geyser end space area where the Elon Smart is located. b. Reduce temperature set point by 5 degrees. c. Wait until temperatures cool down. The Elon Smart will start up again. d. Contact technical support if the above doesn't clear the alarm.
8	DC Wiring Insulation Failure	<ul style="list-style-type: none"> a. Check solar panels and DC wiring for insulation faults. b. To operate the Elon Smart whilst the insulation fault has not been located and resolved, you can set the heating profile to <i>Grid Only</i> or switch off the DC disconnect switch.
9	Insulation Self-Test Failed	<ul style="list-style-type: none"> a. Check earth wiring. Make sure both earth straps are connected securely to the geyser earth stud.

ID	Alarm message	How to resolve the alarm
10	AC Wired to DC Input	Wire AC to correct input (see Chapter 4).
11	DC Wired to AC Input	Wire DC to correct input (see Chapter 4).
12	No Power on DC Input	<p>This can be due to several reasons:</p> <ul style="list-style-type: none"> a. There is no DC power connected to the Elon Smart b. DC power is off at the DC disconnect switch close by the Elon Smart unit. c. There is an issue with the DC wiring or solar PV installation. d. It is extremely dark and overcast during daytime. (The alarm is not active when the sun is less than 15 degrees above the horizon.) <p>This alarm won't prevent the Elon Smart unit from functioning and heating water with grid (AC) power as long as there is grid power available.</p> <p>You can clear the alarm by switching the DC power on (where applicable), fixing the DC wiring / solar PV installation, setting the Elon Smart heating policy to <i>Grid Only</i> (see Table 4.1) or you can leave it until DC power returns.</p>
13	DC Input Reversed	The wiring on the Solar input has been installed incorrectly (in reverse). The DC+ (positive) wire has been connected to the DC- (negative) terminal on the Elon Smart and the DC- (negative) wire has been connected to the DC+ (positive) terminal on the Elon Smart. Swap the DC wires around (see Chapter 4).
14	Hot Connection	Elon Smart not correctly inserted into geyser element. Switch off all power to the Elon Smart and re-seat (reinsert) the Elon Smart.

Appendix B. Basic Troubleshooting Guide for Electricians

NOTE: This Troubleshooting Guide is intended for electricians and not general users.

Things to Remember

- After power up, the unit **runs a self-test that takes about 30 seconds**. Once the self-test passes the unit will engage the correct power source determined by the heating policy. If the water is below the temperature set point for the source (Grid or Solar), it will start heating water. You should hear a click when this happens.
- If the two earth wires are not connected to the earth stud the unit will fail the self-test and never start the heating process.
- **The unit will detect the following installation faults** and display them on the configuration screen. These will stop the unit from connecting power to the element until they are cleared:
 1. DC + and DC – are reversed (reversed polarity);
 2. The earth straps are not connected to the earth stud;
 3. AC is connected to DC input;
 4. There is a fault between the solar wiring and earth (insulation failure);
 5. Element faulty (this may happen if you insert the unit so only a single spade connector makes contact with the element);
 6. Unit component failure.
- **The unit will also warn the installer** if there is:
 1. No power on the AC input. The alarm is not shown if heating policy *Solar Only* is selected.
 2. No power on the DC input and it is daytime. The alarm is not shown if heating policy *Grid Only* is selected.
- For any Heating policy except *Grid Only*, solar power is normally engaged except for the periods listed in **Table 4.1**.
- If the unit has no grid power and engaging the element causes the DC voltage of the solar panels to drop below the voltage required to power the unit, the unit disconnects the element. If AC power is supplied, then the unit can run down to 0 V on DC. If the unit disconnects the element, it will stay disconnected for 2 minutes before connecting to the element again.
- If the unit is connected to the grid, it may draw a small amount of power (<3W) from the grid even if *Solar Only* heating policy is selected.
- **How to switch on solar power to element:** Select *Solar Only* heating policy on the configuration screen.
- **How to switch on mains power to element:** Select *Grid Only* heating policy on the configuration screen.

Troubleshooting Steps

1. Open the Elon Smart app and go to the **Configuration** screen. Look at the alarms on the bottom of the screen and follow the instructions.
2. If you cannot access the unit through the application confirm that:
 - a. The DC isolator is closed;
 - b. The AC isolator is closed.

3. If you still cannot access the unit through the app, remove the geyser pocket cover and:
 - a. Visually inspect the wiring ensuring that AC and DC wiring are still inserted into screw terminals;
 - b. Check using a voltage meter that DC voltage is present on the DC screw terminals and polarity is not reversed (**Figure A1**);
 - c. Check using a voltage meter that AC voltage is present on the AC screw terminals (**Figure A2**).



Figure A1 Checking DC voltage



Figure A2 Checking AC voltage

Appendix C. Solar yield

Note: only basic information is provided here. Your solar PV installation design engineer or technician should advise on the best configuration for your specific location, roof structure, etc.

The yield produced by solar PV modules depends on several factors:

- Solar irradiance levels at your location (which varies with time of day, season and weather conditions)
- Geographic features at your location (e.g. mountains or buildings causing morning or afternoon shade)
- Azimuth and tilt of the modules
- Shading
- Ambient temperature (also influenced by wind)

C1. Solar irradiance levels

The map below shows the general solar irradiance levels (GHI or Global Horizontal Irradiance) in South Africa¹:

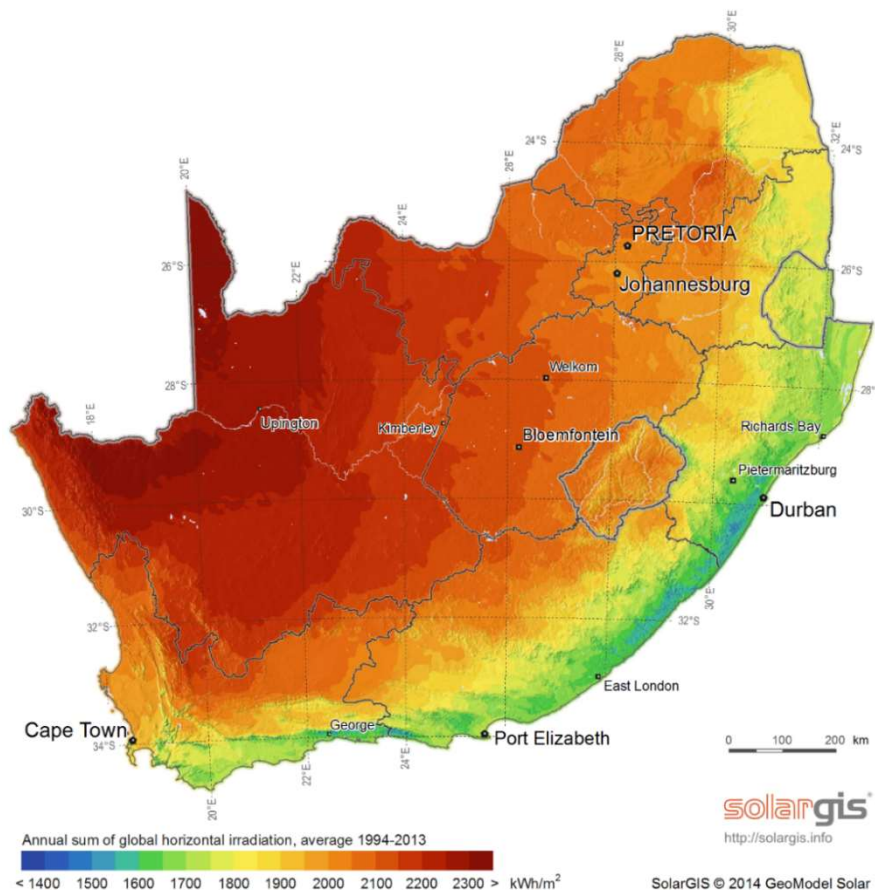

¹ CRSES (Centre for Renewable and Sustainable Energy Studies). Website: http://www.crses.sun.ac.za/files/research/publications/SolarGIS_GHI_South_Africa_width15cm_300dpi.png. Last accessed: 07/04/2017.

You can expect the following approximate energy generation from solar modules for various locations²:

Location	Electricity generated kWh/kWp per year
Bloemfontein	2055
Cape Town	1762
Durban	1570
Johannesburg / Pretoria	1871
Mbombela	1766
Port Elizabeth	1698
Upington	2075

C2. Geographic features

Major geographical features (such as hills or mountains) can reduce the total solar yield.

C3. Azimuth / horizontal angle

The **azimuth** refers to the horizontal orientation of the modules – in the Southern Hemisphere, by how many degrees they are oriented away from north

Due north is best in the Southern hemisphere. Modules should preferably not be oriented more than 15° away from due north.

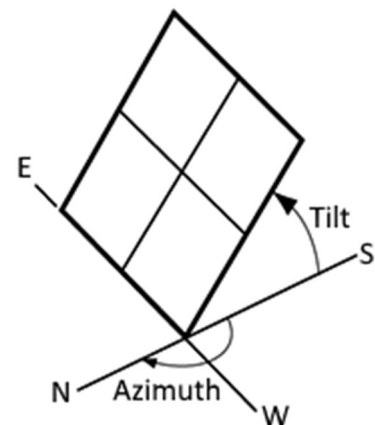

C4. Inclination or tilt angle

The **tilt angle** refers to the vertical orientation of the modules – a rough guide is that the modules should be tilted at the site's latitude. For example, Musina is 22° S, Pretoria & Johannesburg are 26° S, Bloemfontein is 29° S, Durban is 30° S and Cape Town & Gqeberha (Port Elizabeth) are 34° S.

To optimise winter performance, one can add 15° to the tilt angle. (**Note:** as long as you are within about 15° of the optimal latitude, the loss in efficiency is not substantial.)

C5. Shading

Solar modules lose a lot of efficiency if even a small part of the module is shaded. For example, just 3% shading can cause a 25% loss in power! Shaded cells on a module also causes hotspots, which will reduce module lifetime.

² Urban Energy Support. Website: http://www.cityenergy.org.za/uploads/resource_274.pdf. Last accessed: 07/04/2017.

It is thus **important** to place the solar modules on a rooftop area that is **free from shading** for as much as possible of the day (and throughout the year).

C6. Ambient temperature

Solar PV modules' performance decreases with increasing temperature. Wind will reduce the temperature of the solar array and will thus improve performance. Thus, it is important to install rooftop solar modules with an air gap of at least 40 mm between the modules and roof³.

C7. Minimum distance from roof edges

Your solar PV design engineer should prescribe minimum clearance from roof edges that should be maintained for your area based on climatic and wind conditions. Typically, a minimum clearance of 20 to 30 cm should be maintained.

³ D'Orazio M *et al.* 2013. Performance assessment of different roof integrated photovoltaic modules under Mediterranean Climate.

Appendix D. Deciding on Size of Solar Array

Terminology used

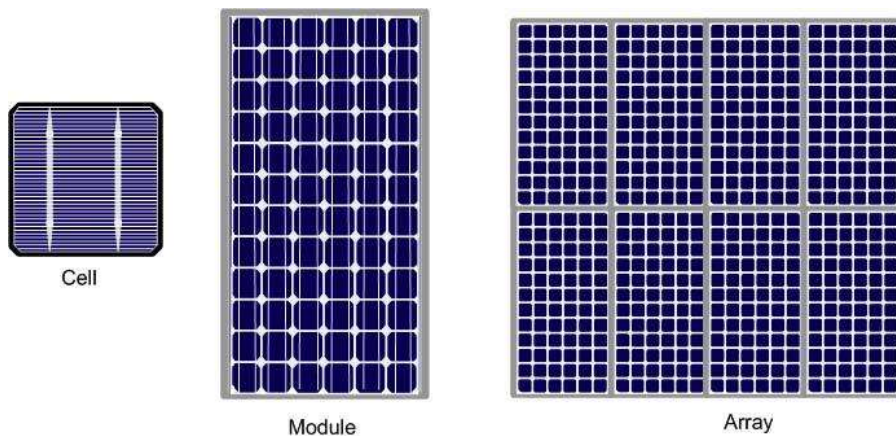

Solar power is generated by solar **cells**, which are arranged in framed **modules**, typically of 60, 72, 120, 144 or 156 cells each. The total set of solar PV modules installed is referred to as a solar PV **array**⁴.

The table below provides a basic guide to selecting the size of the solar PV array based on number of people in the household and/or hot water use. Minimum recommended size is 1 kW_p. Read on for a more detailed guide.

Solar PV array size (kW _p)	Showers per day*	50%+ of daily hot water use provided for how many people?	How many people off-grid for hot water?	Typical number of solar PV modules
1 – 1.2				2 - 3 modules
1.2 – 1.6				3 - 4 modules
1.5 – 2				4 - 5 modules
2.4 – 3.2 (two parallel PV strings)				6 - 8 modules
3 – 4 (two parallel PV strings)				8 - 10 modules

* 6-minute showers at 40 °C with 8 litre/min (low-flow) showerheads

⁴ Image source: <http://ohioline.osu.edu/factsheet/AEX-652-11>.

TABLE D1. ANNUAL AVERAGE LITRES OF WATER HEATED PER DAY

The below example table indicates the average number of litres of water per day that the system will heat from 15 to 60 °C over a year period for different solar array peak power ratings. (The amount of water heated will vary with weather conditions, by geographic location and by season. Water heated per day will be significantly lower in winter and significantly higher in summer. These numbers indicate heating capacity – i.e. if no hot water is used on a given day, there will be less water heated on that day. This is only an **approximate** guide.)

Location	Solar + Elon® kWh/kW _p /yr	Annual average litres of water heated per day for X kW _p installed solar capacity									
		0.8 kW _p	1 kW _p	1.2 kW _p	1.4 kW _p	1.6 kW _p	1.8 kW _p	2 kW _p	2.5 kW _p	3 kW _p	3.5 kW _p
Bloemfontein	1894	80	99	119	139	159	179	199	249	298	348
Cape Town	1624	68	85	102	119	136	154	171	213	256	299
Durban	1447	61	76	91	106	122	137	152	190	228	266
Jhb/Pretoria	1724	72	91	109	127	145	163	181	226	272	317
Mbombela	1627	68	85	103	120	137	154	171	214	256	299
Gqeberha (PE)	1565	66	82	99	115	132	148	164	205	247	288
Upington	1912	80	100	121	141	161	181	201	251	301	352
Saldanha	1623	68	85	102	119	136	153	170	213	256	298

Example:

For a **solar array of 1.2 kW_p**, an installation in **Johannesburg** would yield about 1724 kWh/kW_p/yr, or 1724 x 1.2 kW_p = **2069 kWh/yr**. This would be sufficient to heat on average **109 litres of water per day**. For a family of 2 each using 80 litres of hot water per day, this would provide about 109 ÷ (80 x 2) or **68% of the annual hot water requirement**.

TABLE D2. ANNUAL AVERAGE NUMBER OF SHOWERS PER DAY

The below table indicates the average number of showers per day for which the system will supply hot water over a year period for different solar array peak power ratings. (The amount of water heated will vary with weather conditions, by geographic location and by season. Water heated per day will be significantly lower in winter and significantly higher in summer. These numbers indicate heating capacity – i.e. if no hot water is used on a given day, there will be less water heated on that day. This is only an approximate guide.)

Location	Solar + Elon® kWh/kW _p /yr	Number of showers per day (based on annual average) for X kW _p installed solar capacity								
		0.8 kW _p	1 kW _p	1.2 kW _p	1.4 kW _p	1.6 kW _p	1.8 kW _p	2 kW _p	2.5 kW _p	3 kW _p
Bloemfontein	1894	2.4	3.0	3.6	4.2	4.8	5.4	6.0	7.5	9.0
Cape Town	1624	2.0	2.6	3.1	3.6	4.1	4.6	5.1	6.4	7.7
Durban	1447	1.8	2.3	2.7	3.2	3.6	4.1	4.6	5.7	6.8
Jhb/Pretoria	1724	2.2	2.7	3.3	3.8	4.3	4.9	5.4	6.8	8.2
Mbombela	1627	2.1	2.6	3.1	3.6	4.1	4.6	5.1	6.4	7.7
Gqeberha (PE)	1565	2.0	2.5	3.0	3.5	3.9	4.4	4.9	6.2	7.4
Upington	1912	2.4	3.0	3.6	4.2	4.8	5.4	6.0	7.5	9.0
Saldanha	1623	2.0	2.6	3.1	3.6	4.1	4.6	5.1	6.4	7.7

The table is based on **6-minute** showers at **40 °C** and **8 litres/min** low flow showerheads. Old showerheads can use up to 15 litres/min and would substantially reduce the number of showers.

Example:

For a solar PV array of **2.5 kW_p**, an installation in Johannesburg would yield about 1724 kWh/kW_p/yr, or 1724 x 2.5 kW_p = **4 310 kWh/yr**. This would be sufficient for about **6 to 7 showers per day**.

TABLE D3. PERCENTAGE OF ANNUAL HOT WATER REQUIREMENT

The below example table indicates what % of the annual hot water requirement will on average be supplied by the system for **2 people each using 80 litres of hot (60 °C) water per day**. (The amount of water heated will vary with weather conditions, by geographic location and by season. Water heated per day will be significantly lower in winter and significantly higher in summer. These numbers indicate heating capacity – i.e. if no hot water is used on a given day, there will be less water heated on that day. This is only an **approximate** guide.)

Location	Solar + Elon® kWh/kW _p /yr	Annual average % of hot water requirement supplied for 2 people each using 80 litres of hot water per day for X kW _p installed solar capacity								
		0.8 kW _p	1 kW _p	1.2 kW _p	1.4 kW _p	1.6 kW _p	1.8 kW _p	2 kW _p	2.5 kW _p	3 kW _p
Bloemfontein	1894	50%	62%	75%	87%	99%	112%	124%	155%	187%
Cape Town	1624	43%	53%	64%	75%	85%	96%	107%	133%	160%
Durban	1447	38%	47%	57%	66%	76%	85%	95%	119%	142%
Jhb/Pretoria	1724	45%	57%	68%	79%	91%	102%	113%	142%	170%
Nelspruit	1627	43%	53%	64%	75%	85%	96%	107%	134%	160%
Gqeberha (PE)	1565	41%	51%	62%	72%	82%	92%	103%	128%	154%
Upington	1912	50%	63%	75%	88%	100%	113%	126%	157%	188%
Saldanha	1623	43%	53%	64%	75%	85%	96%	107%	133%	160%

Examples:

An array of **1.2 kW_p** will provide approximately **64%** of the annual hot water requirement for a family of **two people in Cape Town**.

An array of **2 kW_p** will provide approximately $124\% \times (2 \text{ people} / 4 \text{ people}) = \mathbf{62\%}$ of the annual hot water requirement for a family of **four people in Bloemfontein**.

Appendix E. PV array and geyser (water heater) element matching

It is important to match PV array specifications and heating elements for maximum power transfer efficiency. See the below table for the recommended heating element power rating for different solar array sizes.

Contact PowerOptimal for advice on module-element matching if module properties are significantly different to typical values or **for advice on bifacial, high current & high voltage modules.**

TABLE E1. GUIDE: PV ARRAY AND GEYSER (WATER HEATER) ELEMENT MATCHING

Solar PV array size (kW _p)	Best matching geyser element size (kW)	2 nd choice geyser element size* (kW)	Geyser (water tank) size (litres)
1 – 1.6	4	3	100 - 200
1.6 – 2	3	4 or 2	100 - 200
2 – 3	3	4	150 – 300

* Second choice element size would reduce efficiency by 10 – 20%.

DO NOT DEVIATE FROM THE RECOMMENDED MODULE-ELEMENT MATCHING CONFIGURATIONS WITHOUT CONSULTING POWEROPTIMAL.

Maximum allowed solar PV array specifications at Standard Test Conditions (STC):
 $I_{sc} < 15A$ $V_{oc} < 230V$ **Power < 3 kW_p**

Appendix F. Technical Specification Summary: Elon® Smart

Refer to the PowerOptimal website for the full Technical Specification

www.poweroptimal.com/specifications

Rated input voltage	230V AC, 230V DC
Rated input current	18A AC, 15A DC
Mains (AC) voltage range	230V +10% -15%
System power supply	Solar PV DC or 230V AC mains
Power consumption	3W on either AC or DC (solar) power
Data retention on device	2 weeks for high-resolution server data, 1 year for mobile app data
Solar voltage	30 – 230 V DC
Thermostat	Electronic thermostat with 0.5 °C accuracy
Safety	Electromechanical thermal cutout
Reverse polarity protection	For solar PV connections
Lightning protection	8 kA
Self-tests	Component failure, wiring failure, element failure, insulation failure, hot connections
Enclosure ingress protection rating	IP40
Annual energy production compared to inverter-based system	> 90% when solar PV array and geyser element are matched correctly
Standards conformance	SANS 60730-1, SANS 60730-2-7, SANS 60730-2-9, SANS / EN 301 489-1, SANS / EN 301 489-17, ICASA Type Approval, LoA from NRCS
Dimensions & weight	23 x 12 x 11 cm, 0.3 kg
Patents	ZA 2019/02129 (granted), GB2583814B (granted), ZA 2022/08516 (granted), EP 4100979 (granted), US 17/797,977 (pending), GB2206504.9 (pending)
Registered Designs	ZA F2022/00962 (granted), F2022/00963 (granted)
Communications link	Wi-Fi Client, Wi-Fi Hotspot (2.4 GHz)
Measurements	AC energy, voltage, current (5%) DC energy, voltage, current (5%) Temperature: water & ambient
Data logging	15-second data retained for 14 days 5-minute data retained for 366 days
Other features	Mobile app for installers and users Full installation self-check Remote firmware upgrades 50 000+ switching operations on thermostat

It is important to match modules and heating elements for maximum power transfer efficiency. See the tables in **Appendix E** for the recommended heating element power rating for different solar module specifications and array configurations.

Appendix G. Surge Protection Device (SPD) Recommendations

This Appendix outlines under which circumstances a Surge Protection Device should be installed as part of a solar PV system installation such as the Elon® Smart.

G1. SANS 10142-1 The wiring of premises Part 1: Low-voltage installations

Please note: compliance with SANS 10142-1 is compulsory for all electrical installations as per the Occupational Health & Safety Act.

SANS 10142-1 states the following with regards to surge protection:

6.7.6 Surge protection

*6.7.6.1 Surge protective devices (SPDs) **may be installed** to protect an installation against transient overvoltages and surge currents such as those due to switching operations or those induced by atmospheric discharges (lightning). NOTE A risk assessment may be performed in accordance with annex Q. The Installation of SPDs is necessary where structures are equipped with external lightning protection systems (LPS) as in accordance with SANS 10313.*

As can be seen above, surge protection is optional and based on a risk assessment as per Annex Q.

The risk assessment is as per the following table from SANS 10142-1 (2020):

Table Q.1.1 — Surge Protection Requirements for residential Buildings

Surge protection requirements for RESIDENTIAL buildings									
Lightning Flash Density (Ng)	RURAL ENVIRONMENT			SUBURBAN ENVIRONMENT			URBAN ENVIRONMENT		
	Service Line (l)	Type of SPD Required		Service Line (l)	Type of SPD Required		Service Line (l)	Type of SPD Required	
$0 \leq Ng < 3$	> 62 m	T2	5 kA	> 85 m	T2	5 kA	> 425 m	T2	5 kA
$3 \leq Ng < 7$	> 26 m	T2	5 kA	> 36 m	T2	5 kA	> 182 m	T2	5 kA
$7 \leq Ng < 11$	> 17 m	T2	20 kA	> 23 m	T2	20 kA	> 115 m	T2	20 kA
$Ng \geq 11$	> 13 m	T2	20 kA	> 17 m	T2	20 kA	> 85 m	T2	20 kA

Note that the “Service Line” referred to above is the incoming (AC) line for the house.

Here is a lightning density map for South Africa as provided in SANS 10142-1:

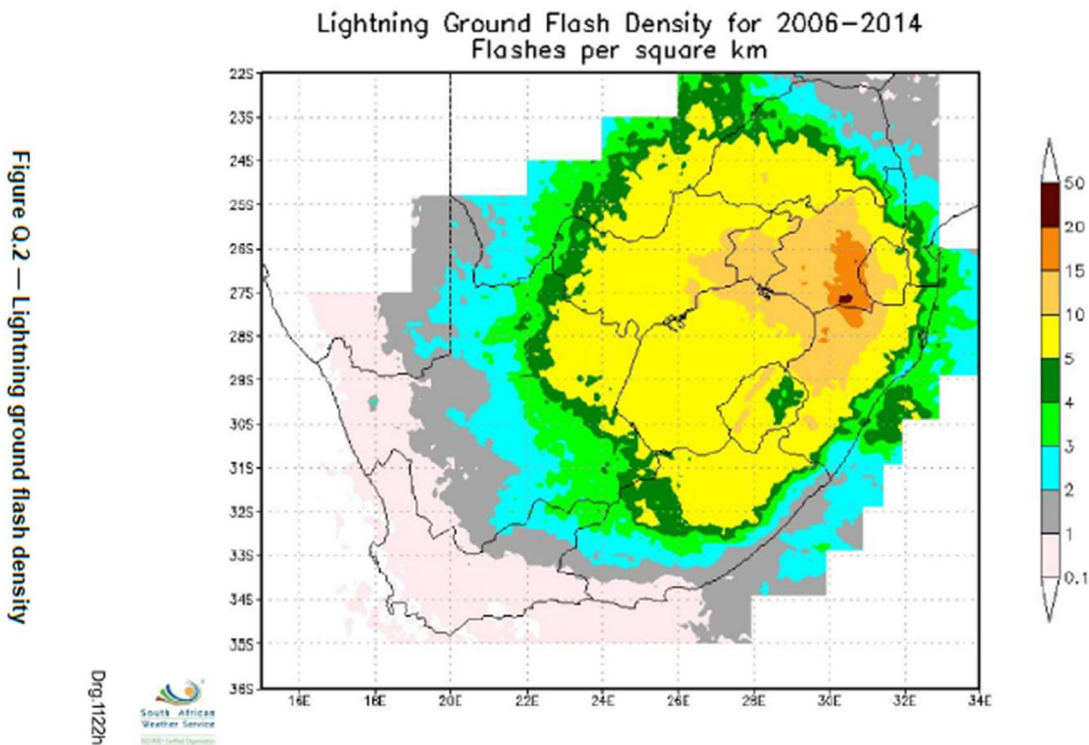

G2. SANS 60364-7-712 (2018) Low Voltage Electrical Installations: Requirements for special installations or locations – Solar photovoltaic (PV) power supply systems

Section 712.443.5.101 of SANS 60364-7-712 requires a Surge Protection Device to be installed on the DC side of the installation where the length (**L**) of the DC cables (from PV array to Elon® Smart or inverter) exceeds the critical length **L_{crit}** as follows:

A Surge Protection Device is required where **L ≥ L_{crit}**

The critical length **L_{crit}** depends on the type of PV installation and is calculated according to the following table:

Type of installation	Individual residential premises	Terrestrial production plant	Service / Industrial / Agricultural Buildings
L _{crit} (in meter)	115/Ng	200/Ng	450/Ng

where Ng = lightning strike density (number of strikes/km²/yr)

The length of DC cables **L** is the **sum** of:

- distances between the inverter(s) and the junction box(es), while observing that the lengths of cable located in the same conduit are counted only once, and

- distances between the junction box and the connection points of the photovoltaic modules forming the string, observing that the lengths of cable located in the same conduit are counted only once.

For the Elon® Smart, distance L is the length of DC cables from PV array to the Elon® Smart.

On the next page is a national lightning ground stroke density map for South Africa⁵.

From this map, the lightning strike density (Ng) range for major cities are as follows:

City	Lightning strike density Ng (strikes/km ² /yr)	Lcrit (m)	
		Individual residential premises	Service / industrial / agricultural buildings
Cape Town	0.02 to 4	29	113
Stellenbosch	0.02 to 4	29	113
Worcester	0.02 to 4	29	113
George	0.02 to 4	29	113
Saldanha	0.02 to 4	29	113
Gqeberha (Port Elizabeth)	0.02 to 4	29	113
Buffalo City (East London)	4 to 6	19	75
King Williams Town	4 to 6	19	75
Beaufort-West	4 to 6	19	75
Musina	4 to 6	19	75
Britstown	6 to 15	8	30
Durban	6 to 15	8	30
Upington	6 to 15	8	30
Pietermaritzburg	15 to 21	5	21
Greytown	15 to 21	5	21
Polokwane	15 to 21	5	21
Bloemfontein	15 to 21	5	21
Queenstown	15 to 21	5	21
Vryburg	15 to 21	5	21
Mahikeng	15 to 21	5	21
Mbombela (Nelspruit)	15 to 21	5	21
Kimberley	21 to 27	4	16
Pretoria	21 to 27	4	16
Vereeniging	21 to 27	4	16
Welkom	21 to 27	4	16
Johannesburg	27 to 33	3.5	13
Ermelo	33 to 42	2.5	10
Newcastle	33 to 42	2.5	10

⁵ Evert CR, Gijben M. 2017. Official South African Lightning Ground Flash Density Map 2006 to 2017.

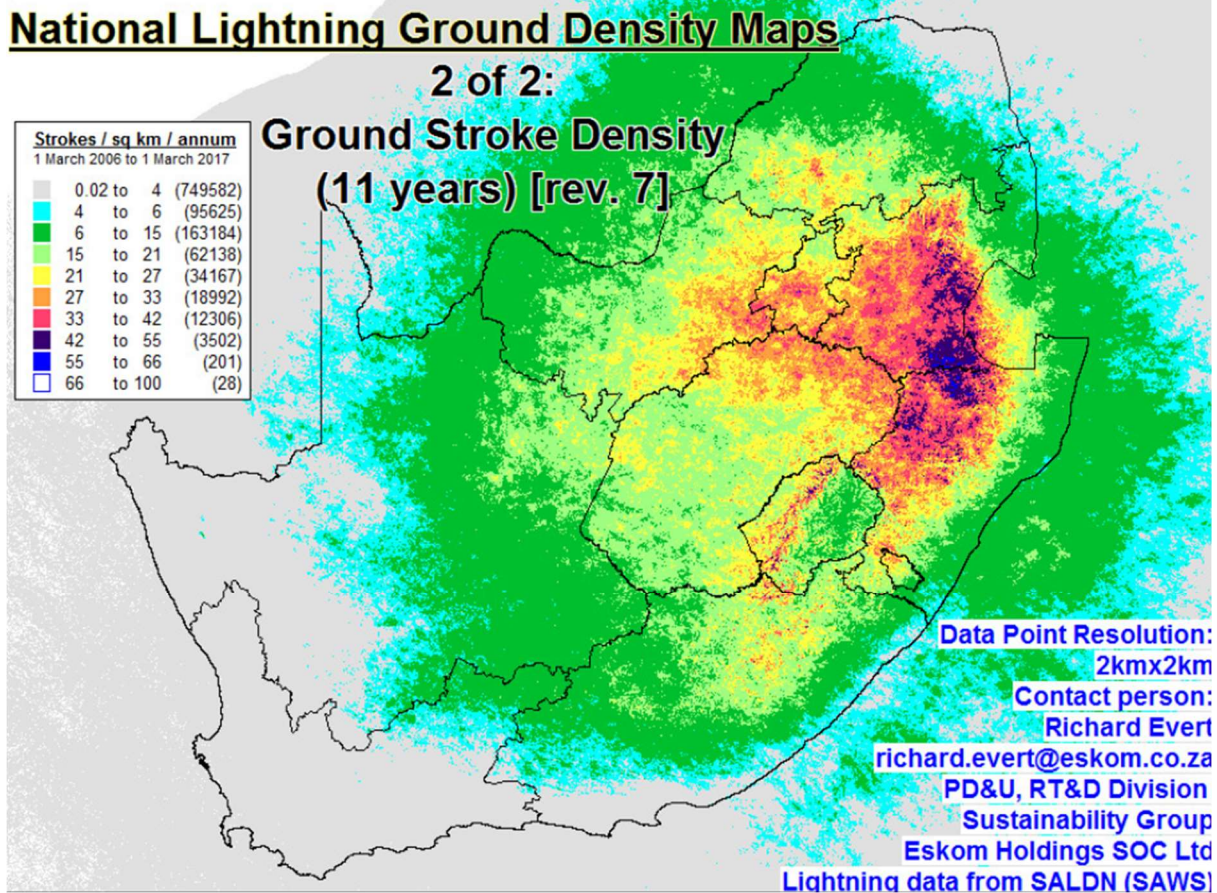

From Evert & Gijben (2017).

Appendix H. IEC/SANS and EMC Test Certificates: Elon® Smart



WCT (PTY) LTD T/A T.E.S.T. Africa
reg #: 2000/024600/07
vat reg #: 4620192684

Building 33, Scientia PO Box 36335
Room S166 Menlopark
Meiring Naudé Road Pretoria, 0102
Pretoria South Africa



Tel.: (+27 12) 349 114
Fax: (+27 12) 349 1249
E-mail: info@testafrica.co.za
Internet: <http://www.testafrica.co.za>



Test Report

IEC 60730-2-9

Automatic electrical controls - Part 2-9: Particular requirements for temperature sensing controls

REPORT # : WCT 24/0519A

CLIENT:

*Electrolux SA (Pty) Ltd
PO Box 389
Benoni
1500
Attention: Ughard De Clercq
Order #: Application Form
Date of Order: 04 April 2024*

SAMPLE:

Smart Thermostat

TEST SPECIFICATION:

SANS 60730-2-9:2013, IEC 60730-2-9:2011 in conjunction with SANS 60730-1:2016, IEC 60730-1:2013

SUMMARY OF RESULTS:

Complied

DATE STARTED:

2024-04-25

DATE COMPLETED:

2024-05-28

DATE OF ISSUE:

2024-05-28

TESTED & APPROVED:

G.H. Holtzhausen (Technical signatory)

REVIEWED:

E.P. Kuisis (Test Engineer)

NOTE: This report relates only to the specific sample(s) tested as identified herein. The test results do not apply to any similar items that has not been tested.



WCT (PTY) LTD T/A T.E.S.T. Africa
reg #: 2000/024600/07
vat reg #: 4620192684

Room S166, Building 33 PO Box 36335
CSIR Grounds Menlopark
Scientia, Pretoria Pretoria, 0102
0135 South Africa

Tel.: (+27 12) 349 114
Fax.: (+27 12) 3491249
E-mail: info@testafrica.co.za
Internet : <http://www.testafrica.co.za>



Test Report

IEC 62368-1

Audio / video, information and communication technology equipment
Part 1: Safety requirements

REPORT # : WCT 24/0519

CLIENT:

*Electrolux SA (Pty) Ltd
PO B ox 389
Benoni
1500
Attention: Ughard De Clercq
Order #: Application Form
Date of Order: 04 April 2024*

SAMPLE:

Smart Thermostat – Communication Module

TEST SPECIFICATION:

SANS 62368-1:2020/ IEC 62368-1:2018

SUMMARY OF RESULTS:

Complied

DATE STARTED:

2024-04-10

DATE COMPLETED:

2024-05-27

DATE OF ISSUE:

2024-05-27

TESTED & APPROVED:

GH Holzhausen (Technical signatory)

REVIEWED:

LP Kuisis (Test Engineer)

NOTE: This report relates only to the specific sample(s) tested as identified herein. The test results do not apply to any similar items that has not been tested.

Page 1 of 44



EMC TEST REPORT

TEST STANDARD(S)	:	ETSI EN 301 489-1: V2.2.3 ETSI EN 301 489-17: V3.2.4 EN 60730-1:2016+A1+A2:2022 EN 60730-2-9:2019+A1+A2:2020
CLIENT / APPLICANT	:	PowerOptimal (Pty) Ltd.
CLIENT ADDRESS	:	88 12 th Avenue Kleinmond 7195
TEST SAMPLE (EUT)	:	Smart Thermostat for Powering a Standard Electrolux Geyser
MODEL NUMBER	:	Elon Smart
VARIANTS	:	None
RESULT	:	Pass
REPORT NUMBER	:	TRE02653/24
DATE ISSUED	:	02/05/2024
REVISION	:	1.0

iSERT (Pty) Ltd. Test reports apply only to the specific sample(s) tested under stated conditions. All samples tested were in good operating condition throughout the entire test program. It is the manufacturer's responsibility to ensure that additional production units of this model are manufactured with identical electrical and mechanical components. iSERT (Pty) Ltd. Shall have no liability for any deductions, inference or generalizations drawn by the client or others from our issued test reports. This report shall not be used to claim, constitute or imply a product endorsement from iSERT (Pty) Ltd.

This test report was prepared by: **Name:** DF Joubert
Title: Junior EMC Engineer

This test report was approved by: **Name:** CJ Deysel
Title: Technical Signatory



T0812

This test report is issued in accordance with SANAS accreditation requirements. SANAS is a signatory to the ILAC Mutual Recognition arrangement for the mutual recognition of the equivalence of testing and calibration reports

Appendix I. Warranty

If the PowerOptimal Elon® Smart (“the Product”) is found to be defective, you will be entitled to a repair or replacement within 2 (two) year of the date of delivery of the Product to you. **Please keep your receipt as proof of purchase or register the Elon Smart online.** If you are a consumer as defined in the Consumer Protection Act No. 68 of 2008 (“the CPA”), you will be entitled to such remedies as are made available under the CPA in relation to the return of goods.

PowerOptimal will not have any liability or obligation to you where the Product has been subjected to abuse, misuse, improper use, improper testing, negligence, accident, alteration, tampering or repair by a third party.

To the maximum extent permitted by applicable law, in no event shall PowerOptimal be liable for any special, incidental, indirect, or consequential damages whatsoever, including, without limitation, damages for loss of business profits or business interruption, arising out of the use or inability to use this product.

Please note that this unit must be installed by an electrical contractor registered with the Department of Labour. Failure to do so may invalidate this warranty. Please keep the CoC (Certificate of Compliance) issued by the electrical contractor on completion of the installation.

Register your Elon Smart online to get an extended 5-year warranty here:

<https://poweroptimal.com/elon-extended-warranty/>

Appendix J. Terminology

AC	Alternating Current – an electric current that reverses its direction many times a second at regular intervals, with voltage typically varying in the form of a sine wave.
CoC	Certificate of Compliance – to be issued by the electrician installing your Elon® Smart system
CPA	Consumer Protection Act No. 68 of 2008
DB	Distribution board – the main electrical distribution board / panel in your home, containing circuit breakers and switches.
DC	Direct Current – an electric current flowing in one direction only. Solar PV modules produce direct current electricity.
Geyser	South African term for a water heater
IEC	International Electrotechnical Commission
I_{mpp}	The solar module current at maximum power point (MPP). Manufacturers usually report two I_{mpp} values: one at STC and one at NOCT.
kWh	A derived unit of energy equal to 3.6 MJ (megajoules). The amount of energy used by a 1 kW electrical device over a period of 1 hour.
kW_p or W_p	The peak power rating in kilowatt (kW) or watt (W) of a solar module or array – i.e., the output power achieved under full solar radiation. This is usually reported at STC and NOCT.
MPP	Maximum power point. This is the point on a solar cell, module or array's power or I-V (current-voltage) curve that has the highest power output.
NOCT	Nominal Operating Cell Temperature (also sometimes referred to as NMOT or Nominal Module Operating Temperature). This refers to the temperature that open circuited solar PV modules will reach under conditions that more closely match actual field operational conditions than STC. The modules are tested at 800 W/m ² simulated solar irradiance, 20 °C ambient temperature, 1 m/s wind velocity and open back side mounting. Depending on the quality of the cell / module design, the NOCT can reach anything from 33 to 58 °C ⁶ . Since solar PV cell power output reduces with increase in temperature, a lower NOCT is better.
PV	Photovoltaic – referring to the production of electric current at the junction of two materials exposed to light.
SANS	South African National Standards
STC	Standard Test Conditions for solar cells – 1000 W/m ² simulated solar irradiance and 25 °C solar cell temperature, and an air mass 1.5 spectrum (AM1.5).
V_{mpp}	The solar module voltage at maximum power point (MPP). Manufacturers usually report two V_{mpp} values: one at STC and one at NOCT.

⁶ Source: <http://pveducation.org/pvcdrom/modules/nominal-operating-cell-temperature>.

